

Panoramic Power Modbus TCP Programmer's Guide

Gen 4/4+ Bridge

Firmware v471 / December 2019



Contents

- Introduction and overview..... 3
- Hardware & Networking requirements 4
 - Supported Hardware..... 4
 - Supported LAN networks 4
 - Assigning a fixed bridge IP address 4
 - Bridge configuration..... 4
 - NTP requirements 4
 - Modbus parameters..... 5
- Bridge Modbus Software Model 6
 - Modbus Register Map..... 6
 - Sensor slot allocation example..... 7
 - Sensor Readings..... 8
 - Pulse counter registers 9
- Sensor Calibration keys..... 9
- Bridge Configuration for stand-alone mode 10
 - Connect to the bridge web interface..... 10
 - Set networking mode 10
 - Set Connection mode..... 10
 - Define bridge UI accessibility..... 11
 - Assign sensors to slots..... 12
 - View Sensor Readings 13
 - Configure the bridge Pulse interface 14
- Bridge led configuration for stand-alone mode..... 14

Introduction and overview

This document covers the operation and interface definition of the Panoramic Power bridge when working in the stand-alone mode. In this mode, the bridge implements a Modbus TCP protocol which sends sensor's current readings to a local server. The local server acts as a Modbus master server and the bridge acts as a Modbus TCP slave.

This guide focuses on the new bridge stand-alone (Modbus TCP) operational mode. It is supplementary to the [Gen 4 Bridge User Guide](#) which covers basic bridge operations and should be reviewed prior to using this guide. We plan to merge these two guides in the future.

The image below depicts a typical network diagram for a bridge operating in the stand-alone mode:

- Sensors transmit readings once every 10 seconds to the bridge via proprietary wireless communications.
- For each configured sensor, the bridge stores the last received measurement in memory. It will be stored until overridden by a new measurement from the same sensor or until the bridge resets.
- A Modbus TCP master device (typically a computer or PLC) connects to the bridge via local area network (LAN) and polls the bridges for sensor data.
- The Modbus master device can connect to multiple bridges, each of them receiving multiple sensors.
- Bridge configuration is done via the bridge's built in web server, using the web browser of a laptop connected in the LAN.

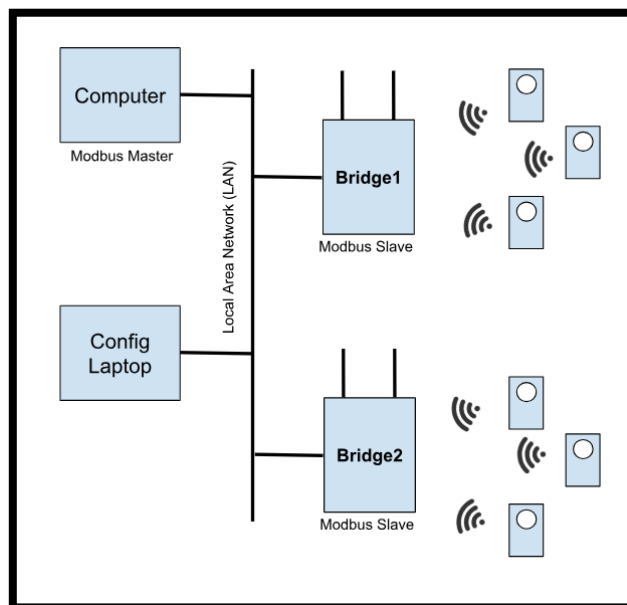

Figure 1: Network diagram

Hardware & Networking requirements

Supported Hardware

- The Modbus TCP solution supports PAN10, PAN12 and PAN14 sensors only. PAN42 is not supported.
- The Modbus TCP also support reading the bridge's pulse inputs (Gen4 and above)
- The Modbus TCP solution is supported by every Gen3/Gen4/Gen4.5 bridge. Upgrading the bridge firmware to the latest version (V.470 and above) is needed for the support of the Modbus TCP interface.
- Each bridge supports up to 32 sensors in stand-alone mode

Supported LAN networks

To work in the Modbus TCP mode, the bridge has to be set-up for Ethernet or WiFi network connectivity. A bridge configured for cellular network connectivity does not support Modbus TCP.

Assigning a fixed bridge IP address

For Modbus TCP to operate properly, the Modbus master must be able to repeatedly reach a specific bridge via its IP address or DNS name. The solution requires a fixed IP address assigned for the bridge. This can be done by selecting 'fixed IP' in the bridge network settings, or alternatively using DHCP but ensuring that the DHCP server always assigns the same IP address to the specific bridge.

Please refer to the [Gen 4 Bridge User Guide](#) for more information about configuring the bridge networking.

Bridge configuration

Bridge configuration is done from a laptop's web browser using the bridge built-in web server.

Initial bridge configuration, including setting up a fixed IP address to be used later, is done via a directly connected laptop. Please see 'Accessing the bridge web interface' section in the [Gen 4 Bridge User Guide](#).

Once a fixed IP has been assigned to the bridge; further configuration can be done by navigating to the bridge IP address from a web browser. The laptop used for such configuration must have HTTP route to the bridge.

NTP requirements

In order to operate properly the bridge needs to get the real time clock (RTC). Since the bridge has no battery-powered hardware RTC, it gets the time using a standard NTP server.

The bridge gets the NTP time, as part of the boot process, using the following process:

1. If a dedicated NTP server IP is defined, it will try to get the time from that server
2. Alternatively, it will try to get the time from a list of well-known public NTP servers
3. If both options above fail it will get the time from PowerRadar.

Option 3 above only works in 'PowerRadar connected mode' or 'combined mode' (See 'Connection Setup' section below). Therefore, when working in 'Stand-Alone Modbus TCP' mode an NTP server must be defined in the LAN or alternatively, NTP outbound access to public servers must be implemented in the firewall.

Another option is to set the real-time clock via the Modbus Interface. This will override any time retrieved during the boot process.

Modbus parameters

These parameters are needed when setting up the connection from the Modbus Master:

- The bridge Modbus interface is enabled via **TCP port 502**
- Recommended timeout value for the Master is **5 seconds**
- **Little endian** word order is used

Bridge Modbus Software Model

Modbus Register Map

This section is for use by the Modbus Host programmer. The image below shows the bridge register map as reflected to the Modbus Master:

Type	Functional Code	Register # (Dec)	Description	Size (16 bit words)	Format	Comments
Bridge date/time						
R/W	R- 4 W-16	0001 0002	Bridge date and time (UNIX time)	2	UINT32	Set through Modbus or by NTP
Bridge information						
R	3	0001	Bridge model	1	UINT16	0-GEN3, 1-GEN4, 2- GEN4.5
R	3	0002 0003	Bridge serial #	2	UINT32	Could be used as a test register
R	3	0004	Bridge mode	1	UINT16	1- Standalone, 2- Combined
R	3	0005	Bridge HW version	1	UINT16	
R	3	0006	Bridge FW ver. - Major	1	UINT16	
R	3	0007	Bridge FW ver. - Minor	1	UINT16	
R	3	0008	Bridge Noise Floor [dBm]	1	INT16	
R	3	0009-0010	Assigned slots	2	UINT32	Bit field format. One bit per slot. 1 st slot in LSB. 1 – assigned slot, 0 - unassigned
Sensor Readings [Array of 32 slots, 20 words each]						
R	3	2001+20N	Sensor status	1	UINT16	0-Slot Empty, 1-No message RX, 2- Message RX 3- Message RX , No RTC
R	3	2002+20N 2003+20N	Sensor S/N (0: unassigned slot)	2	UINT32	N=Slot # (0-31)
R	3	2004+20N	Sensor Type	1	UINT16	10 -PAN10, 12-PAN12, 14- PAN14
R	3	2005+20N 2006+20N	Unix Epoc Timestamp (0: RTC not set)	2	UINT32	N=Slot # (0-31)
R	3	2007+20N 2008+20N	Current Reading [A]	2	FLOAT32	N=Slot # (0-31)
R	3	2009+20N	Reading RSSI [dBm]	1	INT16	N=Slot # (0-31)
R	3	2010+20N- 2020+20N	Reserved for future use	11		N=Slot # (0-31)
Pulse Counter #1 Readings						
R	3	5001	Status	1	UINT16	0-Disabled, 1-No pulse received since reboot 2-No RTC, 3- Pulse received since last reboot
R	3	5002-5003	Unix Epoc Timestamp	2	UINT32	(0: RTC not set)
R	3	5004-5005	Count (Pulse #1)	2	UINT32	Accumulated count during the lifetime of the bridge
Pulse Counter #2 Readings						
R	3	5006	Status	1	UINT16	0-Disabled, 1-No pulse received since reboot 2-No RTC, 3- Pulse received since reboot
R	3	5007-5008	Unix Epoc Timestamp	2	UINT32	(0: RTC not set)
R	3	5009-5010	Count (Pulse #2)	2	UINT32	Accumulated count during the lifetime of the bridge

Table 1 Bridge Register Map

Note: When reading or writing 32-bit elements (UINT32 or FLOAT32), it is required to access them in a single Modbus command (with size =2). Accessing them via two separate commands (size=1) may create abnormal results. **Little endian** word order is used.

The map contains 5 main areas:

- **Bridge date/time settings** – This is where the Modbus host can set or read the Realtime clock for the bridge. It can be used if there is no RTC server reachable by the bridge.
- **Bridge information** – Various bridge status data
- **Sensor readings** – An array of 32 slots. This is where the sensor readings are retrieved.
- **Pulse Counter #1 and #2 Readings** – These holds the counters for the two pulse inputs of the bridge.

Sensor slot allocation example

The following image depicts an example of how the sensor software model works:

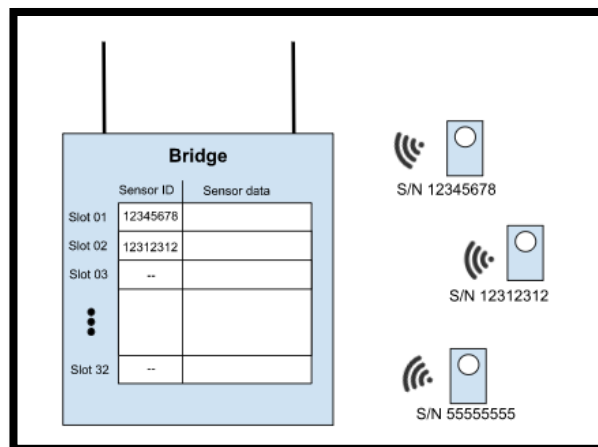

Figure 2: Software model example

In the example above:

- Only two of the 32 bridge slots have been assigned to sensors.
- Slot #1 has been assigned to sensor S/N 12345678
- Slot #2 has been assigned to sensor S/N 12312312
- Slots #3-#32 have not been assigned with any sensors and remain empty.
- Whenever a sensor message from one of the two sensors (12345678 or 12312312) is received, the sensor-data section of the table will be updated. The update will override the previous data.
- We can also see another sensor (S/N 55555555) which is received by the bridge but has not been allocated to any slot. This sensor data will be ignored when the bridge is in Modbus TCP mode.

In 'PowerRadar connected mode' or 'combined mode' all sensor data is simultaneously sent to PowerRadar regardless of the assignment.

Sensor Readings

As seen in Figure 2 above, each sensor slot contains sensor data. This section will review and explain the sensor data stored for each slot.

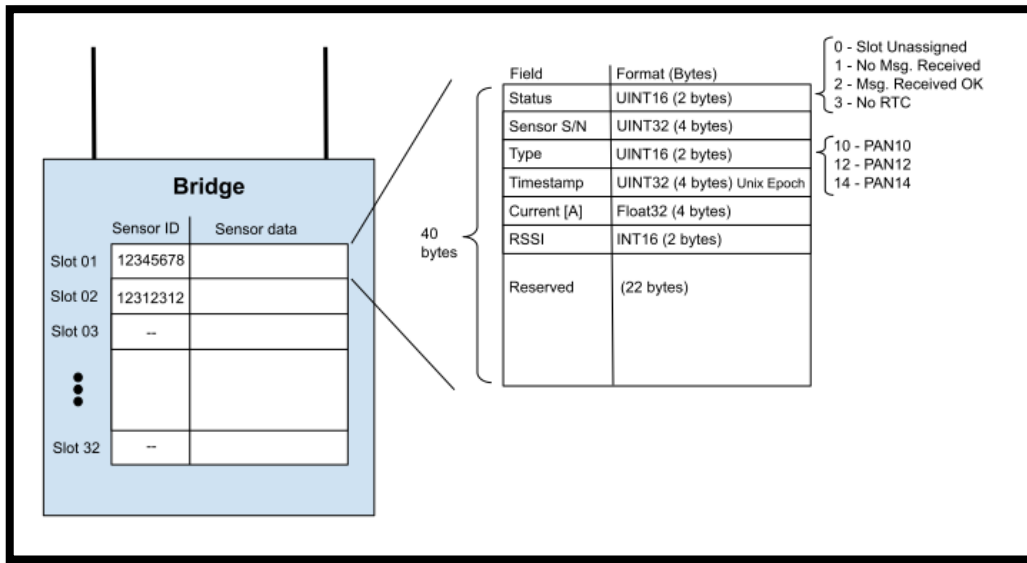

Figure 3 Sensor data storage

As seen in the image, each sensor slot reserve 40 bytes of memory and store the following values:

- **Status** – Indicating the status of the reading of the specific slot.
- **Sensor S/N** – This is the serial number of the sensor associated with this slot
- **Timestamp** – a UNIX Epoch timestamp of the latest message received from the bridge. It is the number of seconds that have elapsed since 00:00:00 Thursday, 1 January 1970, Coordinated Universal Time (UTC), minus leap seconds.
- **Current [A]** – The calibrated current (in A) measured in the last sensor message received.
- **RSSI** – an indication of the RSSI (signal strength) of the last measurement in dBm.

Note: When reading a specific sensor slot data, it is recommended to read the entire 20-word (40 bytes) slot data using a single Modbus command (with size =20), then parse the data in the TCP master.

When reading the data, the status register should be analyzed first. Based on its content the other registers should be processed as shown in the table:

Status	Code	Meaning
0	Slot Unassigned	This slot has no sensor S/N allocation. All other registers in this slot can be ignored.
1	No Msg Received	A sensor S/N has been assigned to this slot, but no sensor message has been received since the last bridge reset. This can be because the sensor is not yet installed, is not in the bridge RF coverage area or because the device monitored by the sensor is off. All other registers in this slot can be ignored.
2	Msg Received OK	A sensor S/N has been assigned to this slot, and a reading has been received. The reading timestamp, Current value and RSSI can be processed.
3	NO RTC	A sensor S/N has been assigned to this slot, and a reading has been received. However, since the bridge has no real-time-clock (RTC) the timestamp value is 0. In this case the Bridge RTC clock should be set via the Bridge Date/Time settings register.

Pulse counter registers

Gen 4 bridges (and above) support two pulse inputs. The bridge counts the pulses on each of the inputs and provides this data in the registers.

Note: The bridge counts both rising and falling edges of the pulse. These registers store the total count. This value is persistent even after bridge reset.

Sensor Calibration keys

Each Panoramic sensor is calibrated during manufacturing and a unique calibration key is generated for every sensor. This key is used to calibrate the sensor raw measurements to achieve optimal accuracy.

When working in PowerRadar mode, raw measurements are calibrated in the cloud. In stand-alone mode, however, the calibration is done on the bridge itself, utilizing a unique calibration key.

The calibration key is a sensor specific, 15 alpha-numeric string (e.g. ACD43-XU3V5-Z7RF3), which must be provided when allocating a sensor to be used in stand-alone mode and dual mode.

To get a calibration key for a specific sensor use one of the following options:

- **Automatically calibration key retrieval** - if the laptop used to configure the bridge has Internet access, a calibration key can be automatically retrieved when defining the sensor in the bridge. This is the easiest and most efficient way to get the calibration key. Internet access is only required for the laptop used to set the bridge and only during the configuration.
- **Manual calibration key retrieval** – In the rare case where internet access is not available during bridge configuration, please contact powerradar-support@centrica.com with the serial numbers of sensors needed. A file containing the respective calibration keys will be provided to be manually entered into the bridge.

Bridge Configuration for stand-alone mode

To work in the stand alone-mode the bridge must be configured via the built-in web interface. This is explained in detail in the [Gen 4 Bridge User Guide](#).

Connect to the bridge web interface

Initial bridge configuration is done by forcing the bridge into configuration mode and directly connecting a laptop with point-to-point ethernet cable.

The full process is defined in the 'Accessing the bridge web interface' section in the [Gen 4 Bridge User Guide](#).

Set networking mode

1. Navigate to the 'Network Setup' tab and set the bridge networking mode
2. Note that only 'Ethernet' and 'Wi-Fi' networks support the stand-alone mode
3. Set the IP configuration for the bridge. A static IP (or DHCP with fixed IP guarantee) must be used in stand-alone mode to allow the master Modbus TCP to repeatedly address this bridge.

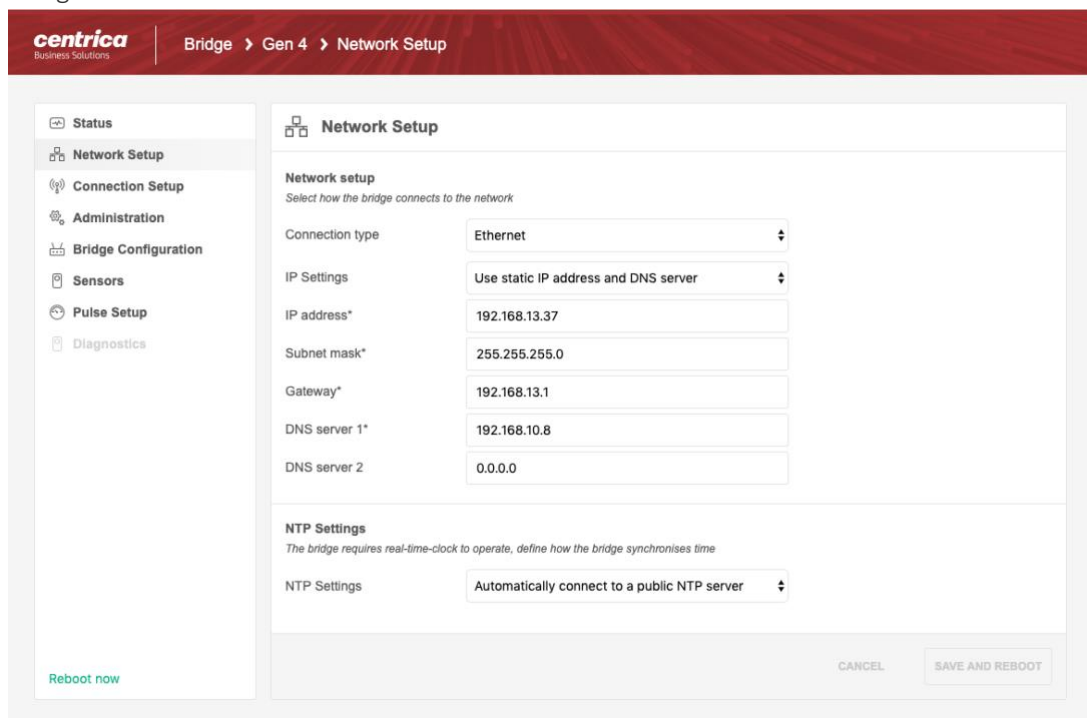

Figure 4 The Network Setup Screen

Set Connection mode

1. Navigate to the 'Connection Setup' tab to set the bridge connection preferences.
2. By default, the bridge is configured to connect to PowerRadar
3. Check 'Enable Stand Alone Modbus TCP' to enable the Modbus TCP option.
4. Note that it is possible to set both 'PowerRadar' and 'Modbus TCP' modes concurrently. In this case:
 - a. The bridge will send sensor data to PowerRadar (all received sensors)
 - b. In parallel, it will make sensor data available for Modbus TCP (allocated sensors only)

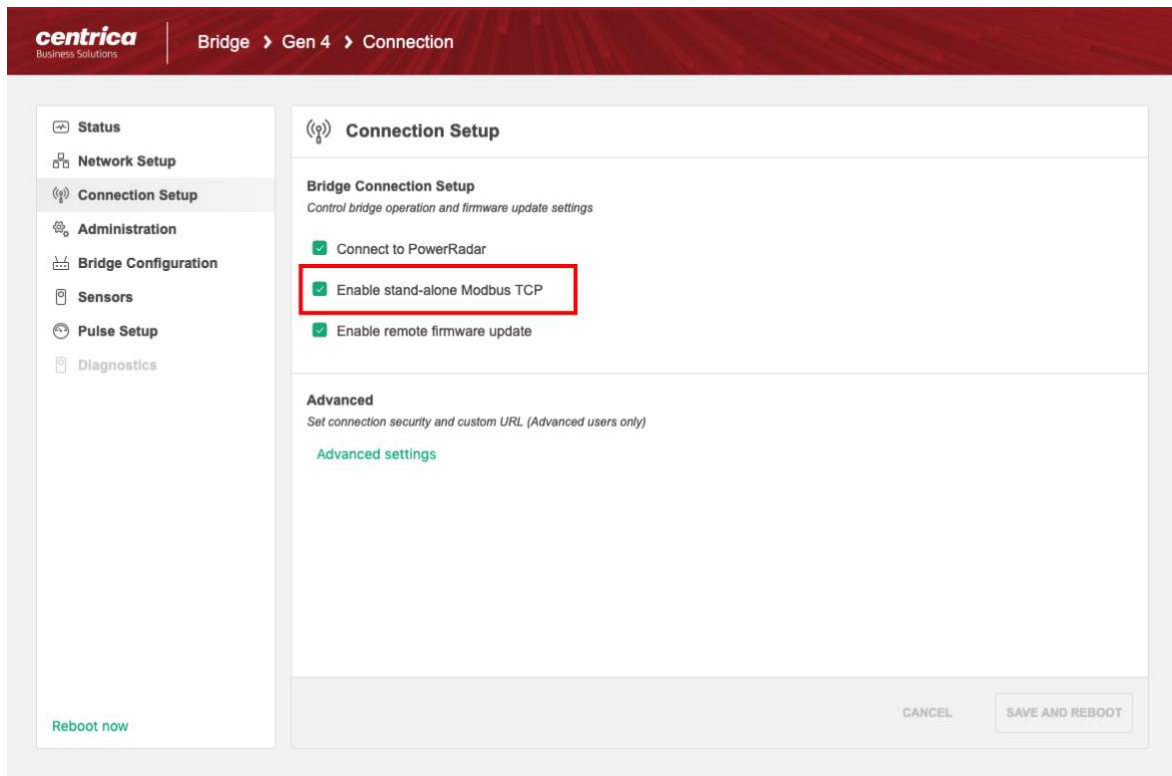

Figure 5 The Connection Setup Screen

Define bridge UI accessibility

For enhanced security, the bridge UI is accessible by default only during configuration mode, using a wired-connected laptop.

It is possible to change that configuration, making the UI accessible from any laptop in the same LAN as the bridge. While less secure, this mode can be useful during testing and sensor setup when multiple frequent changes are made to the bridge UI. Setting up a unique administrator password is strongly recommended.

1. Navigate to the 'Bridge Configuration' tab
2. Choose bridge UI accessibility:
 - a. Choose 'Only in config mode' for maximum security – In this mode the bridge UI is only accessible from laptop with direct Ethernet connection and only when the bridge is placed in Configuration mode.
 - b. Choose 'Always' for maximum flexibility – In this mode the bridge UI is available from any device with bridge network access. This mode is recommended only during setup period and after a unique administrator password is set.

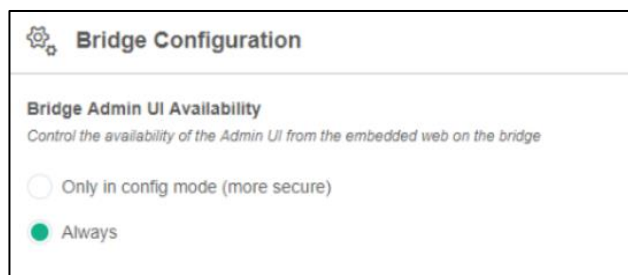

Figure 6 Bridge Configuration

Assign sensors to slots

Any sensor to be used by the Modbus interface must first be allocated to specific location (slot) within the bridge. Once allocated, this sensor readings are guaranteed to always be in a fixed register address.

Readings from sensors that were not assigned to a slot, will not be provided via the Modbus interface (but will continue to be sent to PowerRadar if 'Connect to PowerRadar' is set in the connection configuration page).

Assign a sensor to a slot

1. Navigate to the 'Sensors' tab
2. Choose an empty slot and press the '+' icon
3. In the popup dialog:
 - a. Type the sensor serial number
 - b. Type the calibration key if you have it or click 'Get calibration key' to have it automatically retrieved and inserted.
4. The sensor is now assigned to the slot. New readings will be shown in this screen and made available via the Modbus TCP interface.

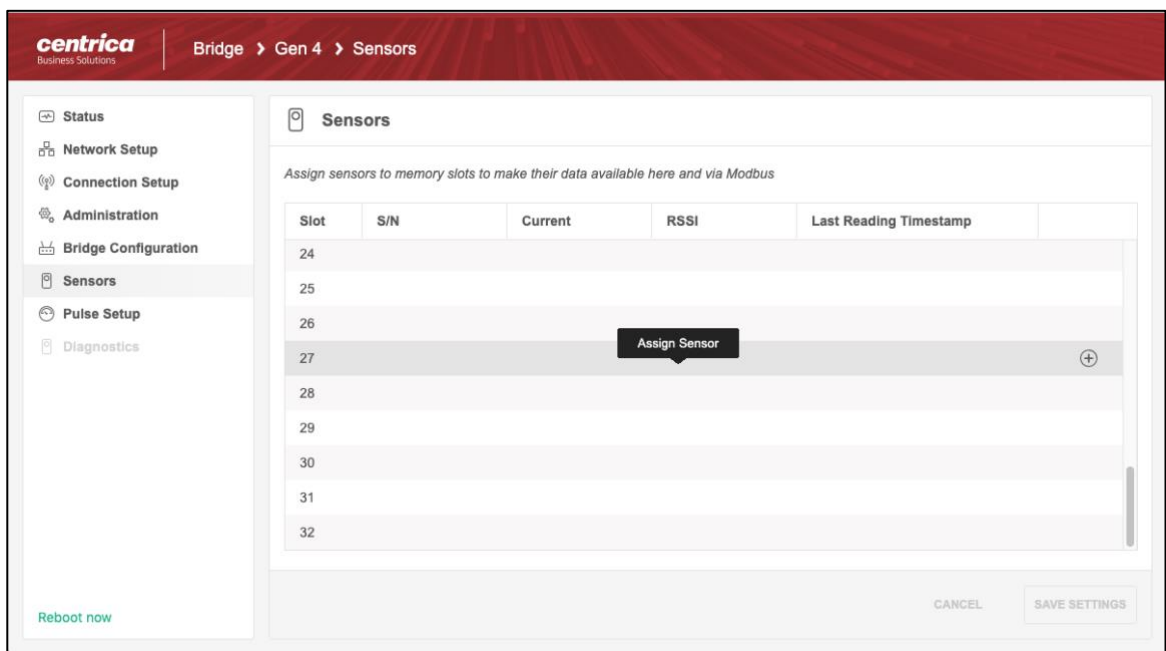

Figure 7 The Sensors Tab

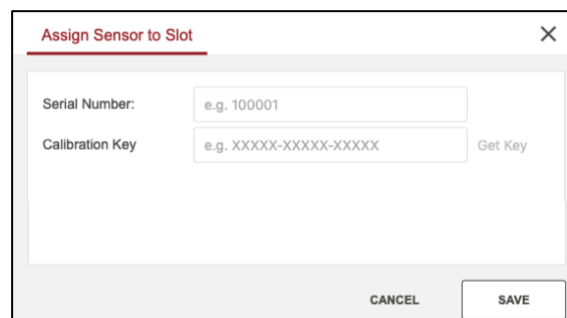

Figure 8 Add Sensor Pop-up

Note 1: Stand-alone mode supports the following sensor types: PAN10, PAN12, PAN14. It does not currently support PAN-42.

Note 2: The calibration key is a unique, per-sensor, value used by the bridge to calibrate each reading for accuracy. It is a mandatory, sensor specific, value.

Note 3: When clicking 'Get Key, your browser communicates with PowerRadar to get the calibration key. It is, therefore, essential that the laptop has Internet connectivity.

Note 4: If having issues retrieving the calibration key, please contact support who can provide an offline list of calibration keys to be entered manually.

View Sensor Readings

Sensor readings are available in the 'Sensors Tab'. Each allocated sensor will display the last received reading. A new reading will override the previous reading.

1. Navigate to the 'Sensors' tab. This Tab is only when 'Connection Setup' > 'Enable Modbus TCP' is checked.
2. Allocated slots will show the following values:
 - a. **Sensor S/N:** The serial number of the allocated sensor
 - b. **Current [A]:** The last calibrated measurement in Ampere.
 - c. **RSSI [dBm]:** The received signal strength of the last measurement.
 - d. **Timestamp:** the time of last measurement.

Note 1: The current readings shown here have already been individually calibrated by the bridge for accuracy, using the calibration key.

Note 2: PAN 10 and PAN 12 current readings can be used as-is. For PAN 14, these values should be multiplied by the CT-Rate of the CT used.

Configure the bridge Pulse interface

1. Navigate to the 'Pulse Setup' tab
2. Enable pulse input 1, 2 or both
3. Enabled pulses are made available for Modbus TCP base on the 'Connection Setup' > 'Enable Modbus TCP' value and are sent to PowerRadar based on the 'Connection Setup' > 'Connect to PowerRadar' value.

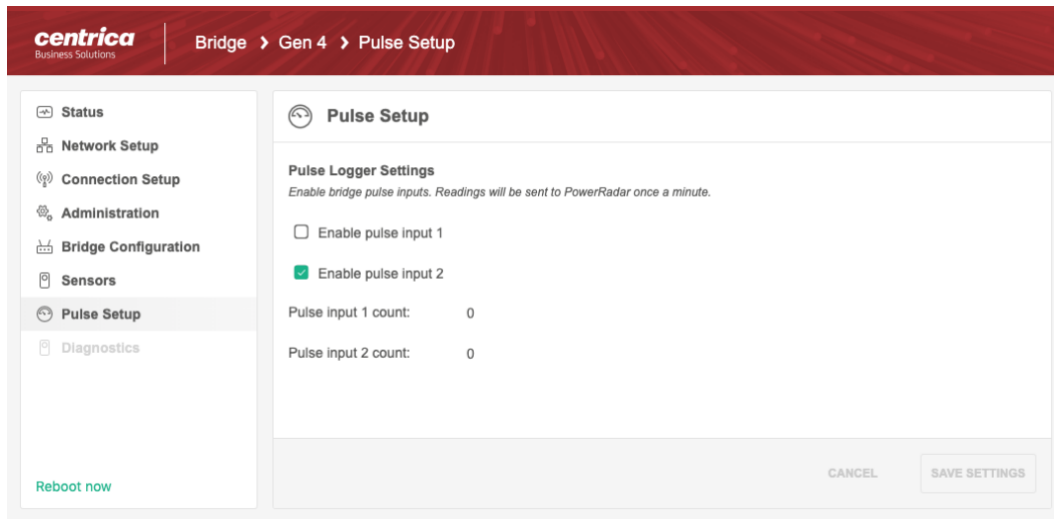

Figure 9 Pulse Setup Tab

Bridge led configuration for stand-alone mode

The bridge contains three hardware LED indicators that change based on bridge operations.

For a full list of led indication states, please refer to the [Gen 4 Bridge User Guide](#). The information below refers to changes in LED behavior in stand-alone mode.

In a 'Standalone mode' the bridge's middle LED (network LED) supports the following behavior:

- **Yellow** blinking until local network connection (Ethernet or Wi-Fi) is established (same as in 'PowerRadar' mode).
- **Green, 1-sec blink** if local network connection is established but no Modbus connection from a master device detected.
- **Solid green** when a Modbus master device connection is detected.

There is no change in LED behavior when in 'PowerRadar' or 'Combined' modes.